



**SOLECTRIA**  
**RENEWABLES**

**PVI 10KW**

**PVI 13KW**

**PVI 15KW**

**INSTALLATION AND OPERATION MANUAL**

Revision B

©2012, Solectria Renewables LLC



**Intertek**

All information subject to change without notice.

## **IMPORTANT REGISTRATION AND WARRANTY INFORMATION**

For warranty to become active, this inverter must be registered. To activate warranty and register inverter, please visit the link below.

[www.solectria.com/registration](http://www.solectria.com/registration)

# IMPORTANT SAFETY INSTRUCTIONS

In this manual “inverter” or “inverters” refers to the inverter models: PVI 10KW, PVI 13KW, and PVI 15KW unless one of the specific models is noted.

This manual contains important instructions that shall be followed during installation and maintenance of the inverter.

To reduce the risk of electrical shock, and to ensure the safe installation and operation of the inverter, the following safety symbols are used to indicate dangerous conditions and important safety instructions:

**WARNING:** This indicates a fact or feature very important for the safety of the user and/or which can cause serious hardware damage if not applied appropriately.



**Use extreme caution when performing this task.**



**NOTE:** This indicates a feature that is important either for optimal and efficient use or optimal system operation.



**EXAMPLE:** This indicates an example.

## SAVE THESE INSTRUCTIONS

## IMPORTANT SAFETY INSTRUCTIONS

- All electrical installations shall be performed in accordance with the local, American or Canadian electrical codes.
- The inverter contains no user serviceable parts. Please contact Solectria Renewables or a Solectria Renewables authorized system installer for maintenance. See Appendix C for Solectria Renewables contact information and authorized system installers.
- Before installing or using the inverter, please read all instructions and caution markings in this manual, on the inverter, as well as on the PV modules.
- Connection of the inverter to the electric utility grid must be completed after receiving prior approval from the utility company and must only be performed by qualified personnel.
- Completely cover the surface of all PV arrays with an opaque material before wiring them. PV arrays produce electrical energy when exposed to light and could create a hazardous condition.
- The inverter enclosure and disconnects must be locked (requiring a tool or key for access) for protection against risk of injury to persons.

## PRESCRIPTIONS DE SECURITE IMPORTANTES

- Tous les travaux d'installation électrique doivent être exécutés en conformité aux normes électriques locales ainsi qu'à la norme nationale américaine et canadienne.
- Le PVI ne contient aucune pièce requérant un entretien effectué par l'utilisateur. Pour toute maintenance, veuillez consulter Solectria Renewables ou un installateur agréé par Solectria Renewables (les coordonnées de Solectria Renewables et des installateurs agréés sont indiquées sur le site web de Solectria Renewables: [www.solren.com](http://www.solren.com)).
- Avant d'installer ou d'utiliser le PVI veuillez lire toutes instructions et toutes les mises en garde présentes dans ce manuel, sur le SGI et sur les modules PV.
- Le raccordement du PVI au réseau électrique ne doit être effectuée qu'après avoir obtenu une entente d'interconnexion auprès de la compagnie locale de distribution électrique et uniquement par du personnel autorisé et qualifié.
- La surface de tous les capteurs PV doivent être recouverte entièrement d'un matériel opaque
- (noir) avant de procéder au câblage. Les capteurs PV exposés a la lumière produisent du courant électrique susceptible de créer une situation de risque.

## CONSERVEZ CES INSTRUCTIONS

## Table of Contents

1.0	Introduction .....	1
2.0	Site Preparation and Inverter Placement .....	3
2.1	Criteria for device mounting: .....	3
3.0	Inverter Mounting.....	5
3.1	Checking for Shipping Damage .....	5
3.2	Removing Inverter from Pallet and Moving Inverter into Place .....	5
3.3	Inverter Positioning and Mounting.....	6
4.0	DC and AC Connections.....	9
4.1	DC and AC Grounds.....	9
4.2	DC Wiring .....	9
4.3	DC Ground Fault Detection and Interruption .....	11
4.4	AC Wiring .....	11
4.5	AC Ground Fault Detection .....	13
4.6	Lightning and Surge Protection.....	13
4.7	SolrenView Monitoring .....	13
5.0	Commissioning the Inverter .....	15
5.1	Turning on the Inverter.....	15
5.2	Operation .....	15
5.3	Turning off the Inverter .....	16
6.0	LCD Display and LED Indicators.....	17
6.1	LCD Display.....	17
6.2	Button Description.....	17
6.3	Screen Descriptions.....	17
6.4	LED Indicators .....	19
7.0	Troubleshooting and Inverter Messages .....	19
7.1	Inverter Messages.....	20
8.0	Product Warranty & RMA Policy.....	22
8.1	Warranty Policy.....	22
8.2	Return Material Authorization Policy .....	26
9.0	Technical Data.....	28
9.1	Output AC Specifications .....	28
9.2	Other Specifications.....	29
9.3	Input DC (PV) Specifications.....	29
9.4	Internal Circuit Diagram .....	31
10.0	Appendices.....	31
10.1	Appendix A – PVI 10-15KW Data Sheet .....	31
10.2	Appendix B – String Sizing Tool.....	31
10.3	Appendix C – Contact Information.....	31
10.4	Authorized Distributors.....	31
10.5	Appendix D – UL1741 / IEEE 1547 / CSA22.2#107.1 Listing Letter .....	32

## 1.0 Introduction

The PVI 10KW, PVI 13KW, and PVI 15KW are commercial, three-phase grid-tied PV inverters designed to be interconnected to the electric utility grid. By following this manual the inverter can be installed and operated safely. This installation guide is used as a reference for commissioning and as a guideline on how to use the inverter most effectively.

Feeding power onto the grid involves conversion of the DC voltage from the PV array to grid compatible AC voltage by inverting DC to AC. This unit feeds power into a standard, three-phase commercial, industrial, institutional or electrical utility facility's electrical system which is connected to the electrical grid.

If the PV system and inverter are providing the same amount of electrical power that the facility is using, then no power is taken from or fed into the utility grid. If the facility is using more power than the PV system is providing, then the utility grid provides the balance of power. If the facility is using less power than the PV system is generating, then the excess is fed into the utility grid.

Be sure to follow local regulations regarding net metering and interconnection in your local area. Note that some utilities need to change their revenue kWh meter for proper net metering measurement and billing.

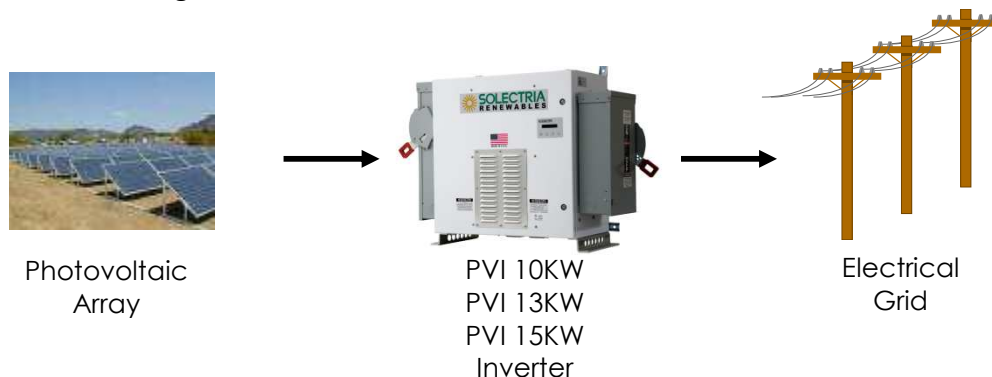

**Figure 1.1 – Grid-Tied Inverter Application**

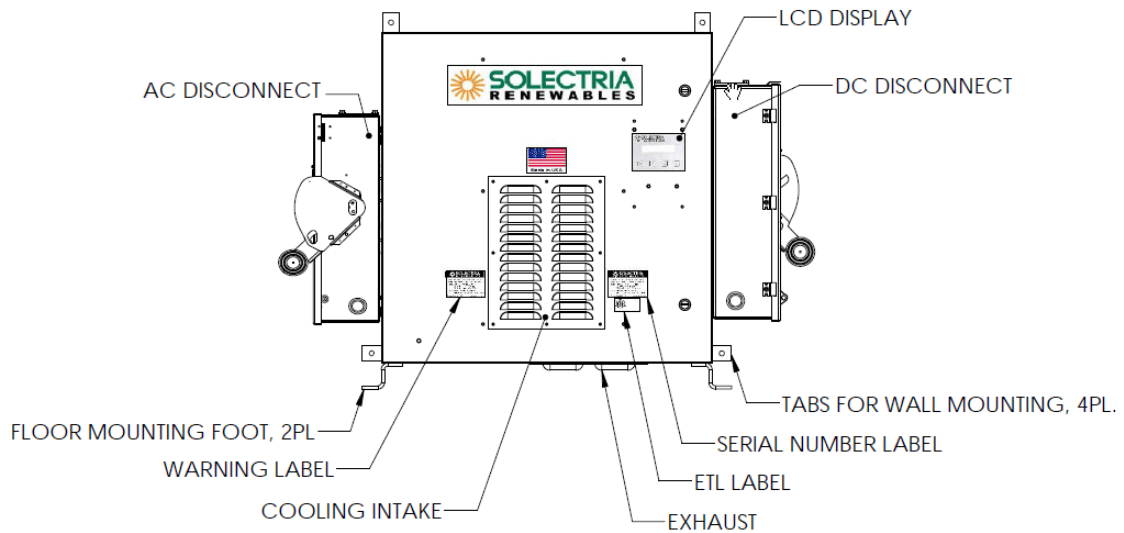

**Figure 1.2 – The PVI 10-15KW Inverter (Side Facing Disconnect Switches) (Front View)**

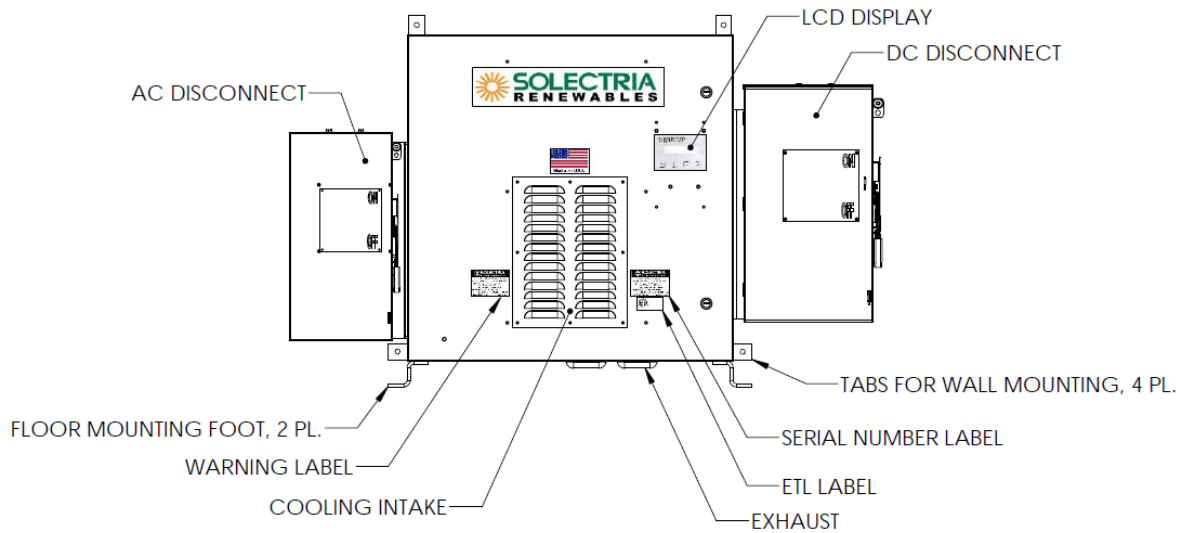

**Figure 1.3 – The PVI 10-15KW Inverter (Forward Facing Disconnect Switches) (Front View)**

## 2.0 Site Preparation and Inverter Placement

The inverter is comprised of a rainproof, industrial enclosure containing electrical and electronic components and AC and DC integrated disconnects.



**NOTE:** If the inverter is mounted outside, ensure that the enclosure doors remain closed during the installation process in case of rain or snow. Leaving these doors open during installation will void the warranty.

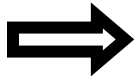

**NOTE:** It is recommended to store the inverter indoors before installation. If the inverter is to be stored outdoors before being installed and commissioned, care must be taken to avoid condensation inside the unit. Removing the protective shipping wrap and placing a small space heater inside the unit can help minimize the amount of condensation that can occur during onsite outdoor storage.

### 2.1 Criteria for device mounting:

- Because the power electronics are within the rainproof enclosure, the inverter can be mounted outdoors.
- The maximum life for the inverter can be achieved by mounting the unit in a clean, dry and cool location.
- For optimal electrical system efficiency, use the shortest possible AC and DC cables and use the maximum allowable cable size.
- Avoid installation in close proximity to people or animals, as there is an audible high-frequency switching noise.
- Install the inverter in an accessible location following local electric codes for enclosure and disconnect switch door clearances and proximity to other equipment.
- Although the inverter is designed to function at full power continuously in up to 50°C ambient temperature, for optimal inverter life and performance, do not mount the inverter in direct sunlight, especially in hot climates. If the unit must be mounted in direct sunlight a metal sun-shield is recommended. It is recommended that the inverter is mounted on the north side of buildings or on the north side of a ground mount PV array.





**CAUTION:** Please follow these guidelines:

- Be sure to verify load capacity of floor, roof or wall mounting area.

Inverter Model	Weight
PVI 10KW	357 lbs.
PVI 13KW	357 lbs.
PVI 15KW	357 lbs.

**Table 2.1 – Weight of Inverters**

- The ambient temperature must be between  $-40^{\circ}\text{C}$  and  $+50^{\circ}\text{C}$  for full power and continuous operation. The inverter will automatically reduce power or may shut down to protect itself if ambient air temperature is outside of the normal operating range.
- The National Electrical Code (NEC) requires the inverter to be connected to a dedicated circuit and no other outlets or device may be connected to this circuit. See NEC Article 690. The NEC also imposes limitations on the size of the inverter and the manner in which it is connected to the utility grid. See NEC Article 690 for guidance within the US.
- The cooling air exhausts at the bottom of the unit. Nothing should block 2 inches of clear space in the bottom of the enclosure, defined by the 2 inch tall mounting feet. Air should be able to flow from the front and to the bottom of the inverter, for proper ventilation. It is also recommended to have 6 inches of clearance on the left and right sides. The inverter must be mounted with at least 2 inches of open space behind it. Air should be able to flow behind the unit from below it to above it.
- A minimum distance of 10 inches must be clear above the inverter for ventilation.
- If you are installing the inverter in a utility vault or electrical closet, the air circulation must be sufficient for heat dissipation. Provide external ventilation to maintain an ambient condition of less than  $50^{\circ}\text{C}$ . The ambient temperature should be kept as low as possible at all times for optimal inverter operation and life.

## 3.0 Inverter Mounting

### 3.1 Checking for Shipping Damage

The inverter is thoroughly checked and tested rigorously before it is shipped. Even though it is bolted onto a rugged, oversized pallet for delivery, the inverter can be damaged during shipping by poor handling, trucking or transfer station activity.

Please inspect the inverter thoroughly after it is delivered. If any damage is seen, immediately notify the shipping company to make a claim. If there is any question about potential shipping damage, contact Solectria Renewables. Photos of the damage will be helpful in documenting potential shipping damage.

- Do not accept the unit if it is visibly damaged or if you note visible damage when signing shipping company receipt.
- Note damage on shipping papers with the truck driver. Report damage immediately to the shipping company.
- Do not remove the unit from pallet/packaging if damage is evident.
- If it is determined that the unit must be returned, a RMA number must be obtained from Solectria Renewables prior to shipping the unit back.

### 3.2 Removing Inverter from Pallet and Moving Inverter into Place

It is recommended to keep the inverter secured to the pallet and moved as close as possible to the final location prior to removing the pallet. To remove the securing bolts use a 1/2" socket and/or wrench. Completely remove each nut and bolt from the pallet.

Use a capable forklift or crane to lift the inverter.

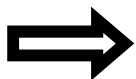

**NOTE:** Failure to follow these lifting guidelines may cause structural damage to the inverter and void the warranty.



**WARNING:** The inverter may tip over if improperly moved, potentially causing damage to equipment, personal injury or death. Do not tilt the pallet or inverter while moving it.



**WARNING:** Do not install the inverter on or over combustible surfaces or materials.



**WARNING:** Connecting the inverter to the electric utility grid must only be completed after receiving prior approval from the utility company. Installation must be performed only by qualified personnel/licensed electrician(s).

### 3.3 Inverter Positioning and Mounting

Correct mounting position for the inverter is vertical with the mounting feet on the floor or back of inverter mounted to a wall.

The PVI 10KW / PVI 13KW / PVI 15KW inverter is made up of a NEMA 3R industrial enclosure containing electrical and electronic components including transformer, filter, contactor, fusing, a sealed power & control electronic inverter unit. The AC and DC disconnect switches are mounted on the sides of the main enclosure. On standard versions, the disconnect switches are side facing. An option is available with forward-facing disconnect switches for tight spaces where width is limited (see Figure 1.3).

Use the mounting diagrams in Figures 3.1, 3.2 or Figures 3.3, 3.4 to choose whether floor or wall mounting will be used. The inverter includes mounting feet for attachment to floors, and mounting tabs for wall mount. You can also use a combination of both mounting provisions. For example, 2 bolts in floor mount feet and 2 bolts in the wall mount tabs.

It is recommended to use galvanized grade 5 or better bolts or stainless steel bolts. The correct bolt size is 3/8" (10mm) diameter. Use a heavy lock washer and flat washer with each bolt. If wall mounting is used, be sure to verify sheer and pullout strength of anchors or other wall attachments.



**WARNING:** Severe injury or death could occur if the inverter mounting fails and the unit tips over or falls on a person.



**NOTE:** The weight of the inverter will exert an added load to floor, roof or pad where mounted. Be sure to verify proper load capacity of mounting surface.

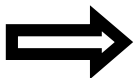

**NOTE:** If the roof/floor mounting only uses the inverter's mounting feet, be sure to use all 4 available foot mount bolt positions.

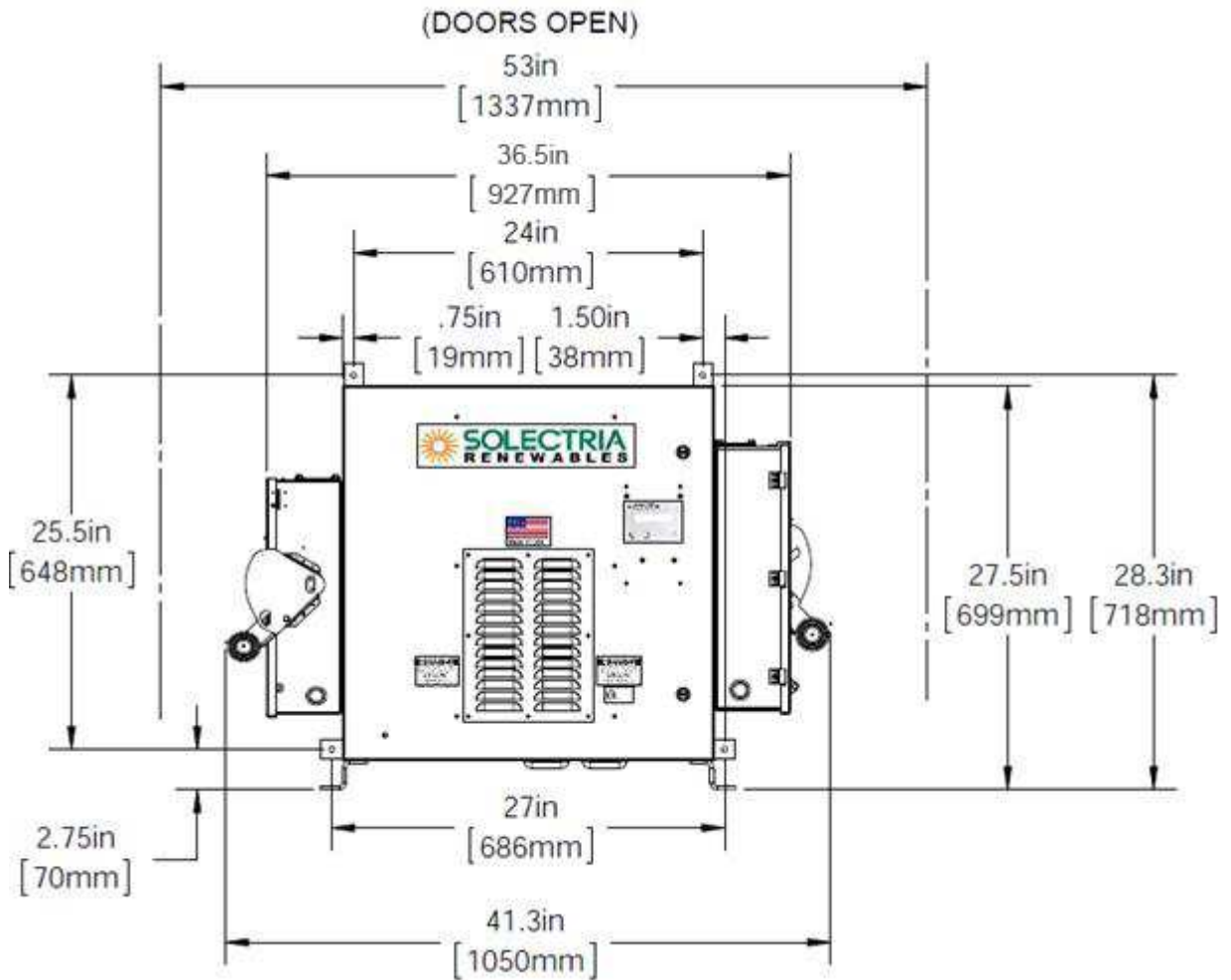

Figure 3.1 – The PVI 10-15KW Inverter Series Dimension (Front View)

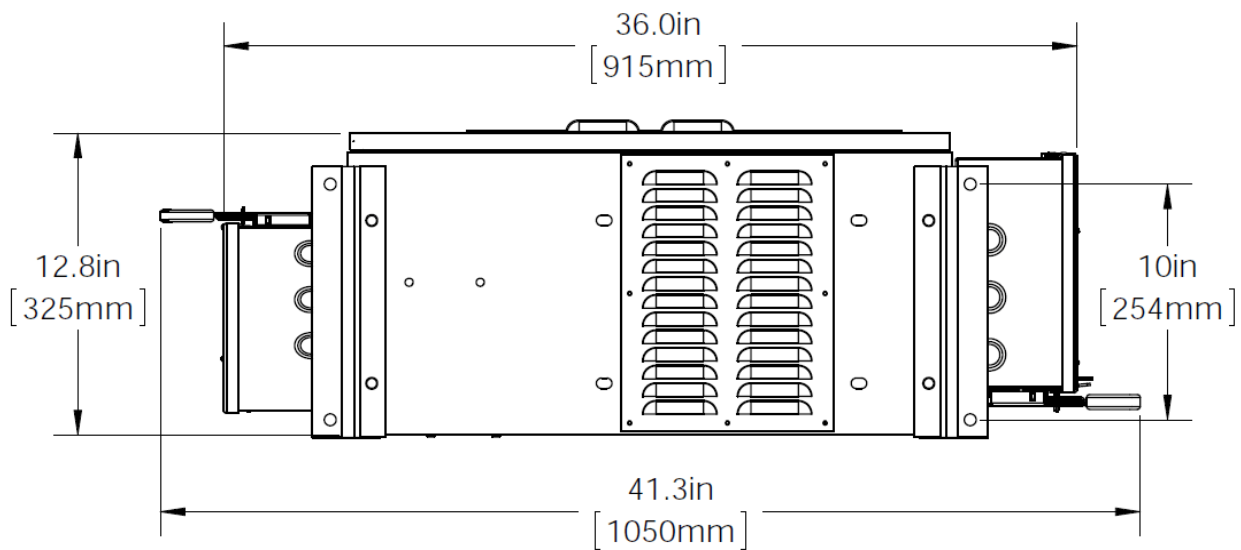
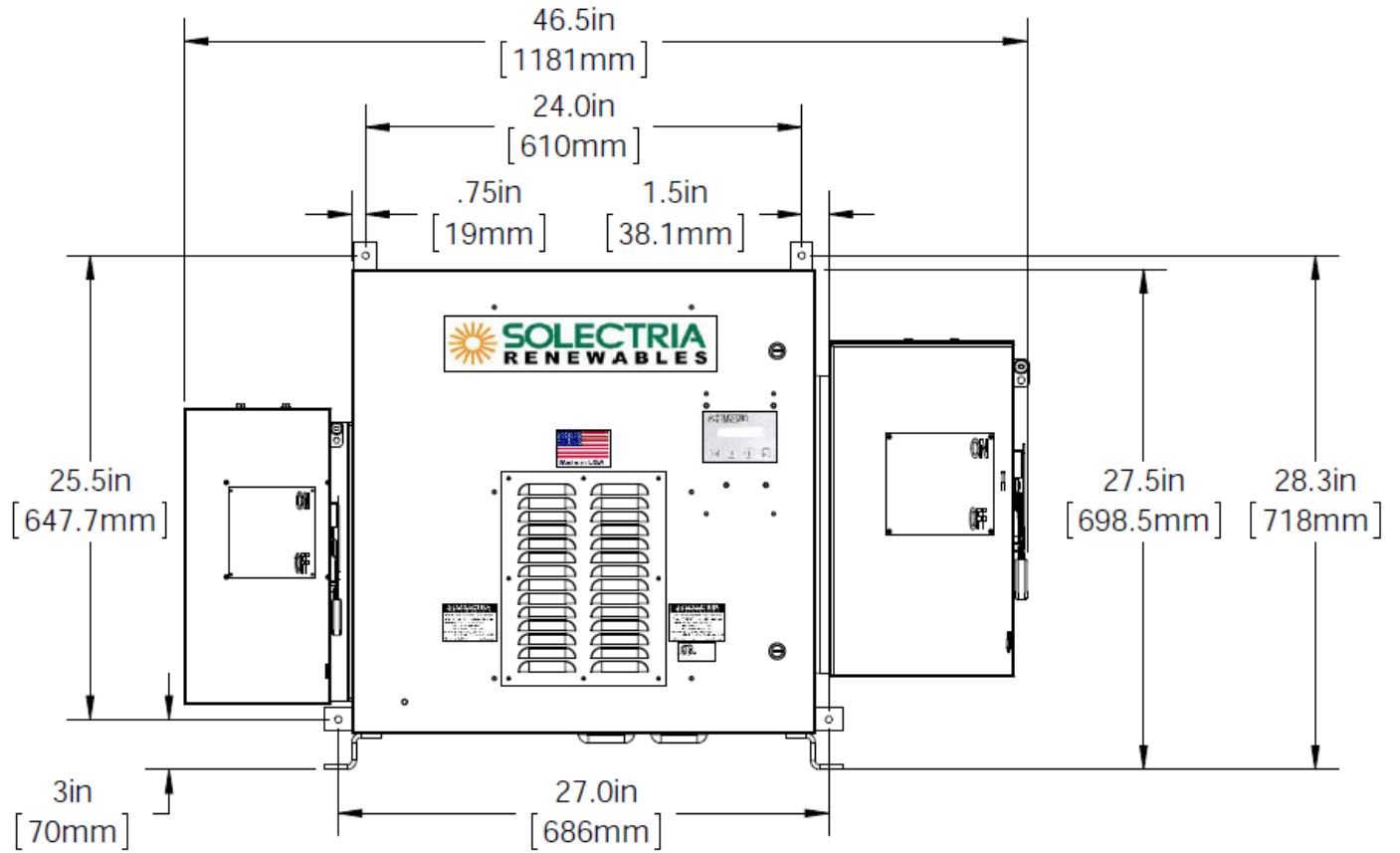
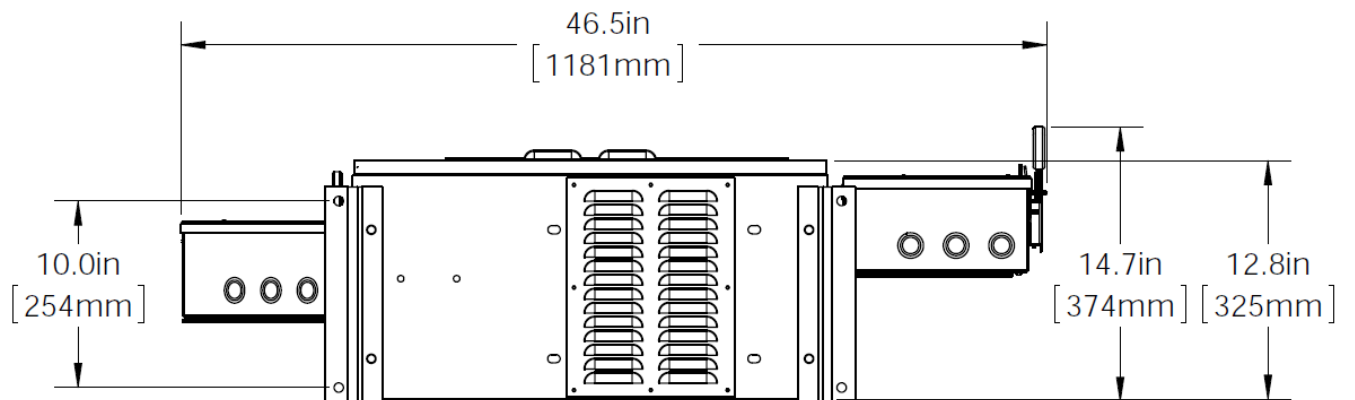

Figure 3.2 – The PVI 10-15KW Inverter Series Mounting Dimensions (Bottom View)



**Figure 3.3 – PVI 10-15KW Inverter Dimensions with Forward Facing Disconnect Switches (Front View)**



**Figure 3.4 –PVI 10-15KW Inverter Dimensions with Forward Facing Disconnect Switches (Bottom View)**

## 4.0 DC and AC Connections



**WARNING:** All electrical installations shall be performed in accordance with all local electrical codes. Only make AC connections directly to the lugs within the AC disconnect switch and DC connections to the lugs within the DC disconnect switch or optional fused combiner.

### 4.1 DC and AC Grounds

The inverter must be properly grounded in accordance with local code. In certain cases, local codes may allow for a common grounding electrode to be used for both the AC and DC grounding electrode. In that instance, the grounding electrode conductor should be connected to the AC ground bar in the AC disconnect switch.

Connection	Number of Open Positions	Wire Range	Torque
DC Ground Bar	2	14 - 4 AWG, Cu	30 in-lb
AC Ground Bar	1	14 - 4 AWG, Cu	30 in-lb

**Table 4.1 - AC and DC Ground Lug Positions**



**WARNING:** Make sure to establish a solid connection from the inverter to the system grounds before proceeding to connect any DC or AC power wires.

### 4.2 DC Wiring



**WARNING:** The wiring connections of the inverter to the DC voltage from the PV strings and the AC voltage of the utility must be performed with the AC and DC disconnect switches off, building AC source circuit panel/breaker off and the PV module strings disconnected.



**WARNING:** Before connecting the DC conductors of the PV array to the disconnect switch or optional fused combiner, verify the polarity of the conductors.



**WARNING:** Before connecting the DC conductors of the PV array to the disconnect switch or optional fused combiner, verify that the DC voltage is less than 475V DC in all conditions. Any DC voltage over 475V will damage the inverter and void the warranty. Configure the array such that the open circuit voltage never exceeds 475V when the modules experience the location's lowest expected temperature. The inverter begins to produce power if the DC open circuit voltage is between 270-430V. Please read the Technical Info section for details.



**WARNING:** Fuses in the inverter's ungrounded, optional fused combiner must only be replaced with the same type and rating fuses as originally installed.

For the **DC wiring without an integrated fused PV combiner**, two conductors are required (one for the grounded conductor and one for the ungrounded conductor) plus additional conductors for grounds (see section 4.1). 90°C copper conductors must be used. The disconnect switch terminals are listed for 75°C wire; see NEC 310.10 or Canadian Electrical Code regarding temperature ratings of wire and terminals. Temperature derating factors, voltage drop and other considerations may dictate that larger than minimum wire sizes be used. Verify that wire size choices meet local codes.

Inverter Model	Maximum DC Input Current	Number of DC Conductors	Minimum DC Wire Size (at Max. DC Input Current)	Maximum DC Wire Size	Torque
PVI 10KW	52A	1	10 AWG, 90°C Cu	1/0 AWG, 90°C Cu	45 in-lb
PVI 13KW	69A	1	10 AWG, 90°C Cu	1/0 AWG, 90°C Cu	45 in-lb
PVI 15KW	77A	1	10 AWG, 90°C Cu	1/0 AWG, 90°C Cu	45 in-lb

**Table 4.2 – Wire Sizes Associated with DC Disconnect Switch**

For the **DC wiring with the optional integrated fused PV combiner**, up to 16 total conductors are required (one for the grounded conductor and one for the ungrounded conductor of each string) plus additional conductors for grounds (see section 4.1). 90°C copper conductors must be used. The combiner terminals are listed for 75°C wire; see NEC 310.10 or Canadian Electrical Code regarding temperature ratings of wire and terminals. Ungrounded conductors (typically the positive DC conductors) are landed in the touch-safe fuse holders. Grounded conductors (typically the negative DC conductors) are landed in the terminal block. Temperature derating factors, voltage drop and other considerations may dictate that larger than minimum wire sizes be used. Verify that any wire size choices meet local codes.

String Fuse Size	Minimum DC Wire Size	Maximum DC Wire Size	Torque (Ungrounded Conductors)	Torque (Grounded Conductor)
6A	10 AWG, 90°C Cu	4 AWG, 90°C Cu	30 in-lb	35 in-lb
8A	10 AWG, 90°C Cu	4 AWG, 90°C Cu	30 in-lb	35 in-lb
10A	10 AWG, 90°C Cu	4 AWG, 90°C Cu	30 in-lb	35 in-lb
12A	10 AWG, 90°C Cu	4 AWG, 90°C Cu	30 in-lb	35 in-lb
15A	10 AWG, 90°C Cu	4 AWG, 90°C Cu	30 in-lb	35 in-lb
20A	10 AWG, 90°C Cu	4 AWG, 90°C Cu	30 in-lb	35 in-lb

**Table 4.3 – Wire Sizes Associated with Optional Integrated Fused PV Combiner**

The grounded DC connections are bonded to the ground system within the inverter through the ground fault detection and interrupt circuit (GFDI). The PV grounded connections should not be bonded to the ground system at any other point. The PV ungrounded connections must never be bonded to the ground system at any time.



**WARNING:** The PV grounded connections should not be bonded to the ground system at any point outside of the inverter. This bond is made in the GFDI circuit that is integral to the inverter.

### 4.3 DC Ground Fault Detection and Interruption

Every PVI 10-15KW inverter is equipped with an automatic DC Ground Fault Detection and Interruption (GFDI) circuit. When a single ground fault on an ungrounded circuit exceeding the pickup value is present in the PV array or in the DC wiring to the inverter, the DC GFDI fuse will blow and a ground fault will be signaled by means of a yellow LED and a message on the front LCD display.

	DC Ground Fault Current Pickup	Maximum Trip Time
PVI 10-15KW	3/4 A	1 s

**Table 4.4 – DC GFDI Specifications**



**WARNING:** In the event of a ground fault, DO NOT TOUCH any equipment (including, but not limited to: the inverter, the PV array disconnects, the PV array combiners, the PV panels, the PV racking system). Immediately contact the installer or another qualified person to locate and repair the source of the ground fault. Be aware that normally grounded conductors and equipment may be energized and may pose a significant shock and / or fire hazard.



**WARNING:** If the GFDI fuse blows upon connection of one or more combined strings, a ground fault in the array must be located and eliminated before proceeding. The DC ground fault is eliminated when the GFDI fuse can be replaced and remains intact. Failure to obey these instructions may cause the grounded conductor to rise to potentially unsafe voltage levels.



**WARNING:** Even when the DC disconnect is in the off position, the ungrounded DC conductor leading up to the DC disconnect will remain live on the PV side as long as the PV modules are in daylight. The inverter side of the DC disconnect will also remain live after the disconnect has been shut off until 60 seconds after the LEDs turn off, as DC bus capacitors in the inverter discharge.

### 4.4 AC Wiring

For the 3-phase AC wiring, for 208V, 240V, and 480V, three conductors are required (one per phase) plus additional conductors for grounds. For 600V, three conductors and a neutral are required, plus additional conductors for ground. 90°C copper conductors must be used. The AC



disconnect switch terminals are listed for 75°C wire; see NEC 310.10 or Canadian Electrical Code regarding temperature ratings of wire and terminals. Temperature derates, voltage drop and other considerations may dictate that larger than minimum wire sizes be used. Verify that wire size choices meet local codes.

Inverter Model	AC Voltage	Number of AC Conductors	Minimum AC Wire Size	Maximum AC Wire Size	Torque
PVI 10KW	208VAC	3 (1 per phase)	8 AWG, 90°C Cu	2 AWG, 90°C Cu	45 In-lb
	240VAC	3 (1 per phase)	10 AWG, 90°C Cu	2 AWG, 90°C Cu	45 In-lb
	480VAC	3 (1 per phase)	14 AWG, 90°C Cu	2 AWG, 90°C Cu	45 In-lb
	600VAC	4 (1 per phase and neutral)	14 AWG, 90°C Cu	2 AWG, 90°C Cu	45 In-lb
PVI 13KW	208VAC	3 (1 per phase)	8 AWG, 90°C Cu	2 AWG, 90°C Cu	45 In-lb
	240VAC	3 (1 per phase)	8 AWG, 90°C Cu	2 AWG, 90°C Cu	45 In-lb
	480VAC	3 (1 per phase)	12 AWG, 90°C Cu	2 AWG, 90°C Cu	45 In-lb
	600VAC	4 (1 per phase and neutral)	12 AWG, 90°C Cu	2 AWG, 90°C Cu	45 In-lb
PVI 15KW	208VAC	3 (1 per phase)	6 AWG, 90°C Cu	2 AWG, 90°C Cu	45 In-lb
	240VAC	3 (1 per phase)	8 AWG, 90°C Cu	2 AWG, 90°C Cu	45 In-lb
	480VAC	3 (1 per phase)	10 AWG, 90°C Cu	2 AWG, 90°C Cu	45 In-lb
	600VAC	4 (1 per phase and neutral)	12 AWG, 90°C Cu	2 AWG, 90°C Cu	45 In-lb

**Table 4.5 – Wire Sizes Associated with Inverter Unfused AC Disconnect Switch**

AC disconnect switch for the PVI 10-15KW is unfused. The inverter must be protected with a dedicated overcurrent protection device. The overcurrent protection device must be adequately rated based on the continuous output current. See NEC 690, NEC 705 and NEC 240 for guidance on sizing the OCPD. The table below summarizes the required ampere rating for nominal 125% rated OCPD's.

Inverter Model	AC Voltage			
	208V	240V	480V	600V
PVI 10KW	35A	30A	15A	15A
PVI 13KW	50A	40A	20A	20A
PVI 15KW	60A	45A	25A	20A

**Table 4.6 – Nominal 125% Rated Backfeed OCPD Ampere Ratings**

Designing for less than 1% AC phase-to-phase voltage rise is highly recommended. Minimizing wiring impedance also results in higher system efficiency. Small conductors and excess wiring impedance forces the voltage at the inverter to be higher than the voltage at the service

entrance. With larger wires, the AC voltages at the inverter will be closer to the voltages at the point of interconnection, allowing for the most reliable inverter operation.

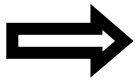

The PVI series of inverters require a **clockwise** phase sequence for proper operation. If a phase sequence error is displayed on the screen during commissioning of the inverter, simply swap any two phases to correct the phase sequence.

#### 4.5 AC Ground Fault Detection

The PVI 10-15KW series of inverters are not equipped with AC ground fault protection. When AC ground fault protection is used on the onsite electrical service, determine if the ground fault device is listed to be backfed. The inverter AC output should be connected on the supply side of the device unless the device is specifically listed for a backfeed application, then the inverter may be installed on either the load or supply side of the device. Always consult the AC ground fault manufacturer for guidance on backfeeding their devices in a Code compliant manner.

#### 4.6 Lightning and Surge Protection

The PVI series is designed with certain protections against surges in voltage including certification to ANSI/IEEE 62.41/62.42. However, added protection and solid grounding provisions are important for best protection against utility surges and surges created by indirect lightning strikes.

The installation of a UL listed lightning arrester of the correct specification is recommended on both the DC and AC inputs of the inverter. This should be installed outside of the disconnect switches and wired using the manufacturer's installation instructions. This device gives important added protection from indirect lightning strikes and the resulting voltage surges that provide protection beyond the inverter's IEEE 1547 requirements.

The best protection against damage from lightning and other voltage surge sources is proper grounding of the system. When required by local codes, it is recommended to establish a grounding electrode system specifically for the PV array, located as close as practical to the array. It is also recommended to have the lightning protection system of the building checked and upgraded if needed before the PV system is installed. These added protections are especially important for areas prone to thunder storms and possible nearby lightning strikes. Although these added precautions will not guarantee that there will be *no* damage from lightning, they can help prevent or limit potential damage.

#### 4.7 SolrenView Monitoring

SolrenView is a state of the art web-based inverter monitoring data logger. The PVI series of inverters are equipped with SolrenView monitoring hardware as part of the display module. To activate the hardware, SolrenView monitoring services must be purchased from Solectria Renewables. An Ethernet cable is then connected to a router with internet access on the premises for IP address assignment.









Connect the cat5 cable to the RJ45 jack on the lower right side of the SolrenView

**Figure 4.1 – Connection of Optional SolrenView Monitoring System**

For multiple inverters at one location it is necessary to connect one Ethernet cable to each inverter then to a router or switch for connection to the customer's broadband internet service.

To enable the SolrenView monitoring data logger follow these steps using the display panel.

1. Press  to enter the display set mode
2. Press  to MONITOR
3. Press  to enter monitor set mode
4. Press  to SRV Mode
5. Press  to activate the change mode
6. Press  to select Yes
7. Press  to confirm

## 5.0 Commissioning the Inverter PV System

Before commissioning, ensure that the inverter is mounted, all connections are made and the inverter is ready to power up.

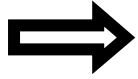

**NOTE:** Make sure all tools, parts, etc. are removed from the vicinity of the inverter before turning on.



**WARNING:** Make a final check of all AC and DC wiring to the inverter and in the system before turning on.

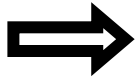

**NOTE:** With the PV modules connected and inverter disconnect switches still off, perform a final check of the PV voltage and polarity once more using a digital volt meter and probing the positive (+) and negative (-) PV connections. Verify clockwise AC phase rotation for L1, L2, L3 using a phase rotation meter.

### 5.1 Turning on the Inverter:

**NOTE: IT IS CRITICAL THAT THE SEQUENCE FOR TURNING ON THE INVERTER BE FOLLOWED EXACTLY.**

- Turn on the dedicated three-phase circuit breaker or disconnect switch at the building service.
- Turn on the inverter's AC disconnect switch.
- Turn on the inverter's DC disconnect switch.
- Watch the LED indicators for initialization (green and red LEDs on), then a slow blinking green LED followed by a faster blinking green LED. Watch the LCD display for prompts and system status.
- Listen for contactor closing (inverter on-line).
- Listen for slight 60 Hz hum (transformer on-line).
- Following the blinking green LED and high frequency switching sound you should see a solid green LED. This confirms that the inverter is operating normally. The LCD display will show the AC Power (PAC), Energy (EAC), current and voltage as well as DC voltage.

### 5.2 Operation

The control electronics will be active as soon as the DC voltage reaches 125VDC. The inverter will go on-line with the utility three-phase grid when the DC voltage first exceeds 270VDC (strike voltage). Next, the inverter will load the array, bringing the DC voltage down from 270VDC to not less than 205VDC.

Once there is enough PV power to back feed three-phase AC power, power switching will automatically feed power to the grid.

### 5.3 Turning off the Inverter

**NOTE: IT IS CRITICAL THAT THE SEQUENCE FOR TURNING OFF THE INVERTER BE FOLLOWED EXACTLY.**

- Use the keypad to temporarily disable the power output. (Set Inverter → Power Disable)
- Turn off the inverter's DC disconnect switch.
- Turn off the inverter's AC disconnect switch.
- Wait at least one minute for the capacitor bank to discharge.

## 6.0 LCD Display and LED Indicators

The inverter operates automatically without the need for user interaction. The LCD display and LED indicators on the front door of the inverter provide valuable inverter operating information.

### 6.1 LCD Display

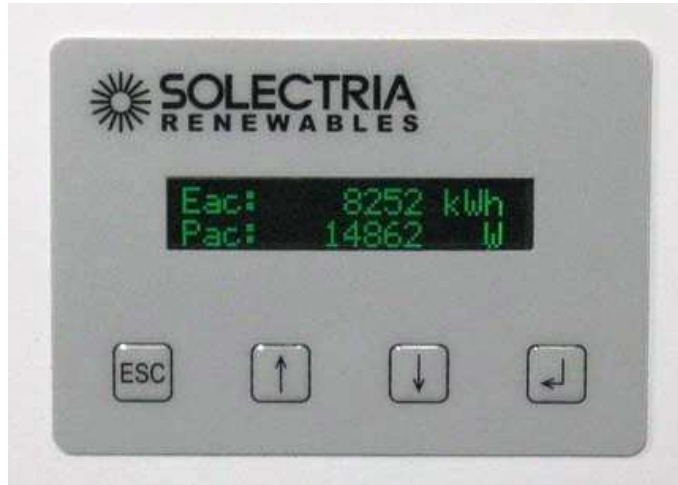

Figure 6.1 – LCD Display

### 6.2 Button Description



To move up a level from the current menu



To scroll up or down within the individual menu items



To enter into selected menu

### 6.3 Screen Descriptions

#### Main Screen (Default)

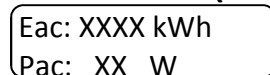



Press or or to move from the main / default screen into the Start Menu. To enter into a selected menu item, press the key.

#### Start Menu

1. Measurements
2. Set Inverter
3. Monitor
4. RG Meter (if installed)
5. Info



## Measurements Menu

This displays the data retrieved from the inverter. Use the   buttons to scroll up and down through the list. Pressing  will take the screen back to the start menu.

AC Energy	<i>Cumulative AC Energy (kWh)</i>
AC Power	<i>AC Power output (W)</i>
AC Voltage	<i>AC Voltage, Three-phase (V)</i>
AC Freq.	<i>AC Frequency (Hz)</i>
AC Current (average)	<i>AC Current, Three-phase average (A)</i>
DC Voltage	<i>DC Voltage (V)</i>
Heat Sink	<i>Heat Sink Temperature (°C)</i>

*Note: data will only be available when inverter is awake and communicating.*

## Set Inverter Menu

This displays inverter parameters, some of which may be modified with the keypad. Use the   buttons to scroll up and down through the list. Pressing  will take the screen back to the start menu.

1. Power Disable	<i>Temporarily disables the AC output of the inverter</i>
2. Inverter ID	<i>Serial port address/ID of the inverter</i>
3. Baud Rate	<i>Serial port baud rate (19200 or 9600)</i>

*Note: data is only available when inverter is operating.*

## Monitor Menu

Displays monitor settings that may be modified with the keypad.

1. LAN *Local Area Network configuration, applicable only for SolrenView monitoring*
  - a. DHCP Mode *See SolrenView manual on DHCP*
  - b. Static/Fallback IP *If DHCP is turned on, this is then used as the fallback IP*
  - c. Gateway IP *IP address of LAN's default gateway*
  - d. Netmask *Subnet mask*
2. Date/Time *Manual time set. This may be overwritten by scheduled NIST updates.*
3. Reboot *Reboots the monitor*
4. Remote SRV *This starts the transmit process necessary for SolrenView monitoring.*  
*Note: Enabling this option when SolrenView service has not been purchased will result in unnecessary wear on the storage memory.*
5. Reset SRV *Settings are cleared to factory defaults. Caution: This will also clear Revenue-grade KYZ counters.*

### 6.4 LED Indicators

The LED indicators mounted on the right side of the inverter enclosure give the installer and user a quick look at what state the inverter is in and if it is operating normally.

GREEN – POWER, the unit is powered up and / or feeding power to the grid

RED – ERROR or FAULT, the inverter is not providing power due to an error or fault

YELLOW - indicates that a ground fault has been detected and it must be located and repaired before the inverter will function. Check GFDI fuse if YELLOW LED remains solid.

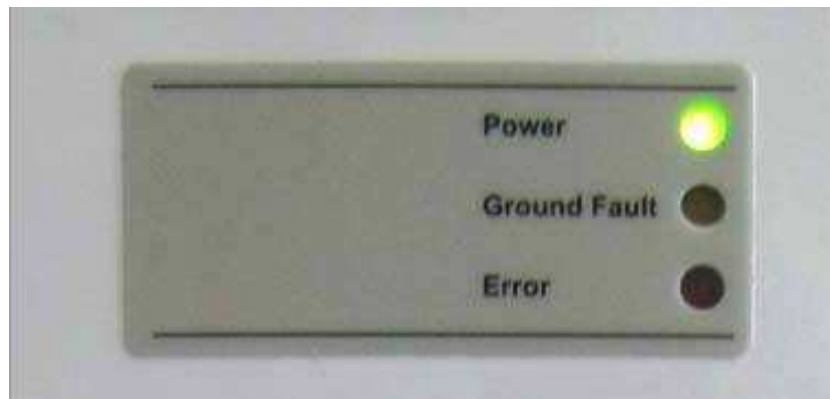

Figure 6.2 – LED Indicators

GREEN	○	A ground fault has been detected in the PV array	DO NOT TOUCH any equipment (including, but not limited to: the inverter, the PV array disconnects, the PV array combiners, the PV panels, the PV racking system). Immediately contact the installer or another qualified person to locate and repair the source of the ground fault.
YELLOW	●		
RED	○		

*For other LED indications please contact Solectria Renewables Customer Support.*

### 7.0 Troubleshooting and Inverter Messages

Although the inverter is designed for many years of power production there may be instances where messages may be displayed on the LCD screen. For ease of diagnostics most messages are displayed as an error message.



### 7.1 Inverter Messages

Pac: XXXX W Power Derating	The inverter is in derating mode. Can be caused by high input power, high temperature, AC line impedance.	Check string sizing, ambient temp, fans operating, vents are clear.
Pac: XXXX W MOV Fault	A high voltage transient has occurred from the AC grid voltage. Usually from lightning.	The inverter will need to be inspected and serviced by an authorized service provider.
Pac: XXXX W AC Voltage High	The AC grid voltage is exceeding the high limit.	Measure the actual VAC compared to the LCD display VAC. If VAC is greater than acceptable limits inverter will restart when normal.
Pac: XXXX W AC Voltage Low	The AC grid voltage is less than the low limit.	Measure the actual VAC compared to the LCD display VAC. If VAC is less than acceptable limits inverter will restart when normal.
Pac: XXXX W AC Freq High	The AC grid frequency is exceeding the high limit.	If possible measure the frequency or contact local utility provider.
Pac: XXXX W AC Freq Low	The AC grid voltage is less than the low limit.	If possible measure the frequency or contact local utility provider.
Contacteur Fail 978-683-9700	The AC contactor or sensing circuit has failed	Turn off the inverter and contact Solectria Renewables. The inverter may need to be serviced by an authorized service provider.
CT Failure 978-683-9700	An internal failure has occurred in one or more of the cores	Turn the DC and AC off, restart the inverter. The inverter may need to be inspected and serviced by an authorized service provider.
Thermal disc. 978-683-9700	The AC contactor is open when it is being commanded to be closed	Turn off the inverter and contact Solectria Renewables. The inverter may need to be serviced by an authorized service provider.
NTC Failure 978-683-9700	The internal temperature sensor has failed.	Turn the DC and AC off, restart the inverter. The inverter may need to be inspected and serviced by an authorized service provider.
IGBT Overtemp 978-683-9700	The internal temperature is exceeding operational limits	Turn the DC and AC off, let the inverter cool to ambient temperature and restart the inverter.
Desat Error 978-683-9700	Internal component sensing fault	Turn the DC and AC off, restart the inverter. The inverter may need to be inspected and serviced by an authorized service provider.
DC GND Fault Check DC Wiring	A ground fault has been detected in the PV array	DO NOT TOUCH any equipment (including, but not limited to: the inverter, the PV array disconnects, the PV array combiners, the PV panels, the PV racking system). Immediately contact the installer or another qualified person to locate and repair the source of the ground fault.

VAC Low Reconnecting	The inverter had a "UL event" and is in the 5 minute wait period	Wait for the inverter to restart
Pac: XXXX W Waiting for grid	Grid voltage may not be present	Check for grid voltage
Reverse phasing & restart PVI!	The VAC grid connection phasing does not match the inverter	Change the phase wire positions at the inverter connection on the grid side
Pac: XXXX W Min Vmpp reached	The power point tracking has been reached	The max power point tracking has reached minimum inverter operating voltage
AC Contact Open 978-683-9700	The AC contactor is open when it is being commanded to be closed	Turn off the inverter and contact Solectria Renewables. The inverter may need to be serviced by an authorized service provider.
Vsense Err 978-683-9700	An internal failure of the voltage sensing circuit has occurred	Turn off the inverter and contact Solectria Renewables. The inverter may need to be serviced by an authorized service provider.
Open Phase 978-683-9700	One of the AC phases is not present at the inverter	Verify that there is AC voltage on all phases at the inverter and all fuses are intact.
MAG Failure 978-683-9700	An internal failure of one of the magnetic components	Turn off the inverter and contact Solectria Renewables. The inverter may need to be serviced by an authorized service provider.
Pac: XXXX W PS Fail	An internal failure of the power stage	Turn off the inverter and contact Solectria Renewables. The inverter may need to be serviced by an authorized service provider.
Pac: XXXX W PS Wake Fail	The power stage did not initialize properly	Turn off the inverter and contact Solectria Renewables. The inverter may need to be serviced by an authorized service provider.
Pac: XXXX W Lost Freq Lock	An internal failure of the voltage sensing circuit	Turn off the inverter and contact Solectria Renewables. The inverter may need to be serviced by an authorized service provider.
Pac: XXXX W VDC Ctrl Fail	The DC voltage is outside of the regulation specifications	Turn off the inverter and contact Solectria Renewables. The inverter may need to be serviced by an authorized service provider.
Pac: XXXX W DMGI Overtemp	The power stage has exceeded its temperature limit	Turn off the inverter and contact Solectria Renewables. The inverter may need to be serviced by an authorized service provider.

## 8.0 Product Warranty & RMA Policy

### 8.1 Warranty Policy

#### **Solectria Renewables Warranty Coverage:**

Solectria Renewables Limited Warranties are provided by Solectria Renewables, LLC. ("Solectria Renewables") and cover defects in workmanship and materials. Solectria Renewables' price for the products is based on inclusion of these limited warranty provisions and disclaimers. In the event of a conflict between the terms of this Limited Warranty and any terms and conditions proposed by purchasers of Solectria Renewables' products, these Limited Warranty provisions shall govern the parties' obligations with respect to warranty coverage for defective products.

#### **Warranty Registration:**

To register the product, please enter the following information at:

<http://www.solren.com/registration>

#### **Duration of a Solectria Renewables Warranty Period:**

For three-phase inverters (PVI 10KW and higher) and for the PVI 1800 and PVI 2500 inverters, the warranty period is 60 months from the date of purchase of the inverter by the end user or 64 months after the delivery date from Solectria Renewables to the distributor or the dealer / installer, whichever is shorter. If a warranty extension has been purchased, the term is defined as an extension beyond 60 months. For example, if a 5 year extension (to 10 years total) is purchased, the term becomes 120 months from date of purchase. For the PVI 3000 to PVI 7500 inverters, the warranty period is 120 months from the date of purchase by the end user or 124 months after the delivery date from Solectria Renewables to the distributor or the dealer / installer, whichever is shorter.

If Solectria Renewables repairs or replaces a product, its warranty continues for the remaining portion of the original Warranty Period or 90 days from the date of the repair/replacement shipment to the customer, whichever is greater.

Solectria Renewables' obligation to repair or replace a defective product under this warranty is contingent upon Solectria Renewables receiving full and timely payment for the warranted products and associated shipping charges. Solectria Renewables Warranty Coverage is voidable, at Solectria Renewables' sole option, if full payment for products and associated shipping charges are not received in full and in a timely manner by Solectria Renewables. Please contact Solectria Renewables Customer Service for further details on other products.

#### **Maintenance Requirements:**

Normal care and preventative maintenance enhances product operation/efficiency. See the product specific Preventative Maintenance requirements detailed within the PM Manuals for each inverter.

**What will Solectria Renewables do?**

Solectria Renewables will, at its sole option, repair or replace the defective product free of charge, provided that Solectria Renewables is notified of the product defect within the Warranty Period for the product, and provided that Solectria Renewables, through inspection, establishes the existence of such a defect and that it is covered by the Limited Warranty.

Solectria Renewables will, at its sole option, use new and / or reconditioned parts in performing warranty repair and/or replacements. Solectria Renewables reserves the right to use parts or products of original or improved design in the repair or replacement of the product. All replaced products and all parts removed from repaired products become the property of Solectria Renewables. Solectria Renewables will attempt to repair the unit within a reasonable time period. No provision will be made for reimbursement of lost energy production.

For three-phase inverters 10kW and higher:

Solectria Renewables covers parts, travel and labor necessary to repair the product and shipment of parts to and from the customer via a Solectria Renewables-selected non-expedited surface freight within the contiguous United States, Canada and Mexico. For Alaska, Hawaii and all other installation locations Solectria Renewables will supply necessary parts as needed for warranty repairs; however, travel is not included. Contact Solectria Renewables customer service for details on the freight policy for return shipments outside of the contiguous United States, Canada and Mexico.

**Obtaining Service:**

If your product requires troubleshooting or warranty service, contact your distributor or dealer / installer. If you are unable to contact your distributor or dealer / installer, or the distributor or dealer / installer is unable to provide service, contact Solectria Renewables directly at the number listed on the website in the customer service section for your product.

Solectria Renewables may send personnel to a jobsite or contract with an area technician, installer or other authorized, trained service personnel to service / replace components.

Reimbursement for contracted services: Solectria Renewables will submit a purchase order to the designated service personnel before work is performed. This purchase order will cover time expected for the required service and most likely an allocation for travel time.

Direct returns may be performed according to the Solectria Renewables Return Material Authorization Policy.

In any warranty claim, dated proof of purchase must accompany the product and the product must not have been disassembled or modified without prior written authorization by Solectria Renewables.

Proof of purchase may be in any one of the following forms:

- The dated purchase receipt from the original purchase of the product at point of sale to the end user, or
- The dated distributor or dealer / installer invoice or purchase receipt showing original equipment manufacturer (OEM) status, or
- The dated invoice or purchase receipt showing the product exchanged under warranty.

Solectria Renewables provides technical assistance Monday-Friday, 8:30am-7pm EST and on-call technical support is provided outside normal business hours.

### **What does the Solectria Renewables warranty not cover?**

Solectria Renewables Limited Warranties do not cover normal wear and tear of the product or costs related to the removal, installation, or troubleshooting of the customer's electrical systems. These warranties do not apply to and Solectria Renewables will not be responsible for any defect in or damage to:

- a) The product, if it has been misused, neglected, improperly installed, physically damaged or altered, either internally or externally, or damaged from improper use or use in an unsuitable environment;
- b) The product, if it has been subjected to fire, water, generalized corrosion, biological infestations, acts of God or input voltage that creates operating conditions beyond the maximum or minimum limits listed in the Solectria Renewables product specifications including high input voltage from generators or lightning strikes;
- c) The product, if repairs have been made to it other than by Solectria Renewables or its authorized, trained service personnel;
- d) The product, if it is used as a component part of a product expressly warranted by another manufacturer;
- e) The product, if its original identification (trademark, serial number) markings have been defaced, altered, or removed;
- f) The product, if it has been damaged in shipping (unless approved in writing by Solectria Renewables);
- g) Any installation and operation beyond the scope covered by relevant safety regulations (UL1741, NFPA 70, etc.);
- h) Third party monitoring equipment.

- i) Failure to perform Preventative Maintenance may void the warranty.

## **DISCLAIMER**

**SOLECTRIA RENEWABLES LIMITED WARRANTIES ARE THE SOLE AND EXCLUSIVE WARRANTY PROVIDED BY SOLECTRIA RENEWABLES IN CONNECTION WITH YOUR SOLECTRIA RENEWABLES PRODUCT AND ARE, WHERE PERMITTED BY LAW, IN LIEU OF ALL OTHER WARRANTIES, CONDITIONS, GUARANTEES, REPRESENTATIONS, OBLIGATIONS AND LIABILITIES, EXPRESS OR IMPLIED, STATUTORY OR OTHERWISE IN CONNECTION WITH THE PRODUCT, HOWEVER ARISING (WHETHER BY CONTRACT, TORT, NEGLIGENCE, PRINCIPLES OF MANUFACTURER'S LIABILITY, OPERATION OF LAW, CONDUCT, STATEMENT OR OTHERWISE), INCLUDING WITHOUT RESTRICTION ANY IMPLIED WARRANTY OF MERCHANTABILITY OR CONDITION OR QUALITY OF THE PRODUCT, ANY IMPLIED WARRANTY OF FITNESS FOR A PARTICULAR PURPOSE, OR ANY IMPLIED WARRANTY OF DISTRIBUTOR OR DEALER/INSTALLER ABILITY, ALL OF WHICH ARE EXPRESSLY DISCLAIMED TO THE FULLEST EXTENT PERMITTED BY LAW.**

**ANY IMPLIED WARRANTIES OF MERCHANTABILITY OR FITNESS FOR A PARTICULAR PURPOSE, OR ANY IMPLIED WARRANTY OF DISTRIBUTOR OR DEALER / INSTALLER ABILITY, TO THE EXTENT REQUIRED UNDER APPLICABLE LAW TO APPLY TO THE PRODUCT, SHALL BE LIMITED IN DURATION TO THE PERIOD STIPULATED UNDER THIS LIMITED WARRANTY, TO THE FULLEST EXTENT PERMITTED BY LAW.**

**IN NO EVENT WILL SOLECTRIA RENEWABLES, INCLUDING ITS SUPPLIERS, MANUFACTURERS, VENDORS, SUBCONTRACTORS, DISTRIBUTORS, DEALERS AND ANY OTHER AFFILIATES BE LIABLE FOR ANY SPECIAL, DIRECT, INDIRECT, INCIDENTAL OR CONSEQUENTIAL DAMAGES, LOSSES, COSTS OR EXPENSES HOWEVER ARISING WHETHER IN CONTRACT OR TORT INCLUDING WITHOUT RESTRICTION ANY ECONOMIC LOSSES OF ANY KIND, ANY LOSS OR DAMAGE TO PROPERTY, INCLUDING LOSS OF USE AND INTANGIBLE HARM OF ANY KIND, AND ANY PHYSICAL DAMAGE OR OTHER DAMAGE ARISING FROM OR AS A RESULT OF ANY USE, MISUSE OR ABUSE OF THE PRODUCT, OR THE INSTALLATION, INTEGRATION OR OPERATION OF THE PRODUCT, REGARDLESS OF WHETHER SUCH INSTALLATION, INTEGRATION OR OPERATION WAS PERFORMED PROPERLY OR IMPROPERLY.**

Solectria Renewables neither assumes nor authorizes any other person to assume for it any other liability in connection with the repair or replacement of the Product.

### **Exclusions of the Policy:**

**If your product is a consumer product, the applicable law may not permit exclusion of implied warranties. To the extent permitted by the applicable law such warranties are limited to the duration of this Limited Warranty. Some jurisdictions do not allow any limitations on the duration of an implied warranty, or exclusions on implied warranties, or on the limitation or**

**exclusion of incidental or consequential damages, so the above limitation(s) or exclusion(s) may not apply to you. This Limited Warranty gives you specific legal rights. You may have other rights, which may vary from state to state or province to province.**

**WITHOUT LIMITING THE GENERALITY OF THE FOREGOING, UNLESS SPECIFICALLY AGREED TO BY IT IN WRITING, SOLECTRIA RENEWABLES**

**(a) MAKES NO WARRANTY AS TO THE ACCURACY, SUFFICIENCY OR SUITABILITY OF ANY TECHNICAL OR OTHER INFORMATION PROVIDED IN MANUALS OR OTHER DOCUMENTATION PROVIDED BY IT IN CONNECTION WITH THE PRODUCT; AND**

**(b) ASSUMES NO RESPONSIBILITY OR LIABILITY FOR LOSSES, DAMAGES, COSTS OR EXPENSES, WHETHER SPECIAL, DIRECT, INDIRECT, CONSEQUENTIAL OR INCIDENTAL, WHICH MIGHT ARISE OUT OF THE USE OF SUCH INFORMATION. THE USE OF ANY SUCH INFORMATION WILL BE ENTIRELY AT THE USERS' RISK.**

#### **WARNING: LIMITATIONS ON USE**

Please refer to your product user manual for limitations on uses of the product. Specifically, please note that Solectria Renewables' products are not intended for use in connection with life support systems and Solectria Renewables makes no warranty or representation in connection with any use of the product for such purposes.

## **8.2 Return Material Authorization Policy**

Please review our Return Merchandise Authorization Policy below.

#### **Obtaining a required, Return Material Authorization:**

Before returning a product directly to Solectria Renewables you must obtain a Return Material Authorization (RMA) number and the correct factory "Ship To" address. Products must also be shipped prepaid. Product shipments will be refused and returned at your expense if they are unauthorized, returned without an RMA number clearly marked on the outside of the shipping box, if they are shipped collect, or if they are shipped to the wrong location.

#### **Information Solectria Renewables needs when you are obtaining service:**

1) The model names and serial number of your product

#### **Preparing the product for shipping:**

1) Package the unit safely, preferably using the original box and packing materials. Please ensure that your product is shipped fully insured in the original packaging or equivalent. This warranty will not apply where the product is damaged due to improper packaging.

2) Include the following:

- a. The RMA number supplied by Solectria Renewables clearly marked on the outside of the box.

- b. A return address to which the unit can be shipped. Post office boxes are not acceptable.
- c. A contact telephone number where you can be reached during work hours.
- d. A brief description of the problem.

Ship the unit prepaid to the address provided by your Solectria Renewables' customer service representative.

**Returning a product from outside of the USA or Canada:**

In addition to the above, you **MUST** include return freight funds and are fully responsible for all documents, duties, tariffs, and deposits.

**Contact information:**

Solectria Renewables LLC  
360 Merrimack Street, Building 9  
Lawrence, Massachusetts, 01843  
USA

Tel: 978.683.9700

Fax: 978.683.9702

Email: [service@solectria.com](mailto:service@solectria.com)

Website: [www.solectria.com](http://www.solectria.com)



## 9.0 Technical Data

### 9.1 Output AC Specifications

The inverters are designed to feed power into a standard 60Hz, three-phase AC utility service provided within a facility by a transformer with a rating of not less than the rating of the inverter(s) connected to it.

The inverter is designed to work with the range of AC voltages for a three-phase service defined by IEEE 1547-2003 and ANSI C84.1.

	PVI 10KW	PVI 13KW	PVI 15KW	Unit
Operating AC Voltage range	88 – 110%			VAC
Turn-on AC voltage range	92 - 105%			VAC
Default over/under voltage trip points and times	per IEEE Std 1547-2003, Table 1 or utility specific order codes			
Voltage measurement accuracy	+/- 2 %			
Operating frequency adjustability	59.3-60.5			Hz
Frequency measurement accuracy	+/- 0.1			Hz
Continuous Output Power 208/240/480/600 VAC	10	13.2	15	kW
Continuous Output Current (208VAC)	28	37	42	Arms
Continuous Output Current (240VAC)	24	32	36	Arms
Continuous Output Current (480VAC)	12	16	18	Arms
Continuous Output Current (600VAC)	9.6	12.7	14.4	Arms
<b>Short Circuit Current Contribution</b>				
Utility Short Circuit Current Output <i>duration of 10 line cycles</i>	Equal to Continuous Output Current			Arms
Peak Short Circuit Current Output <i>duration of less than 300 microseconds</i>	75			Arms
AC current measurement accuracy	+ / - 2%			
AC real power and energy measurement accuracy	+ / - 5%			
Total Harmonic distortion (THD, @ full power)	< 5%			
Power Factor	Unity, >0.99			
Anti-islanding protection	per UL1741 / IEEE1547 / CSA22.2#107.1			

**Table 9.1 – AC Output Specifications**

	PVI 10KW	PVI 13KW	PVI 15KW
Peak Efficiency	96.7%	96.9%	96.6%
CEC Weighted Efficiency (208V)	96.0%		
CEC Weighted Efficiency (480V)	96.0%		

**Table 9.2 –Efficiency of Inverters**

## 9.2 Other Specifications

DC Ground Fault Protection	Per UL 1741
DC String Combiner Range	6/8/10/12/15/20A fuses available, 8 fused inputs
DC Disconnect Switch(Integral)	Break load rated, NEMA 3R
Operational Ambient Temperature	-40° to 122°F (-40° to 50° C) (full power)
Storage Temperature	-40° to 158 °F (-40° to 70° C)
Cooling	Automatic Forced Convection
Inverter Enclosure	Rain Proof per UL1741, NEMA 3R
Switching Electronics Enclosure	Sealed Design

**Table 9.3 – Other Specifications**

## 9.3 Input DC (PV) Specifications

Input (DC) from PV array:

Because the PV modules also have a reduction in voltage at high cell temperatures, you must make sure the MPPT voltage of the strings will not drop below the minimum inverter DC input voltage in very hot temperature conditions.

Both the maximum open circuit voltage (OCV) when at cold extreme and minimum MPPT voltage when at hot extreme can be calculated for a PV module using its specification sheet. PV module string sizing can then be used to determine how many modules can be used in a string. Visit [www.solectria.com/stringizing.html](http://www.solectria.com/stringizing.html) to use Solectria’s interactive string sizing tool.

	PVI 10KW	PVI 13KW	PVI 15KW	Unit
Absolute maximum open circuit voltage	475			VDC
Maximum operating open circuit voltage	430			VDC
Voltage range	205 - 430			VDC
Input voltage MPPT range	205 - 385			VDC
Strike voltage	270			VDC
Wake up voltage	125			
Maximum input current	52	69	77	ADC
DC voltage measurement accuracy	+/- 2%			
DC ground fault fuse rating	3/4			A

**Table 9.4 – DC Input Specifications**

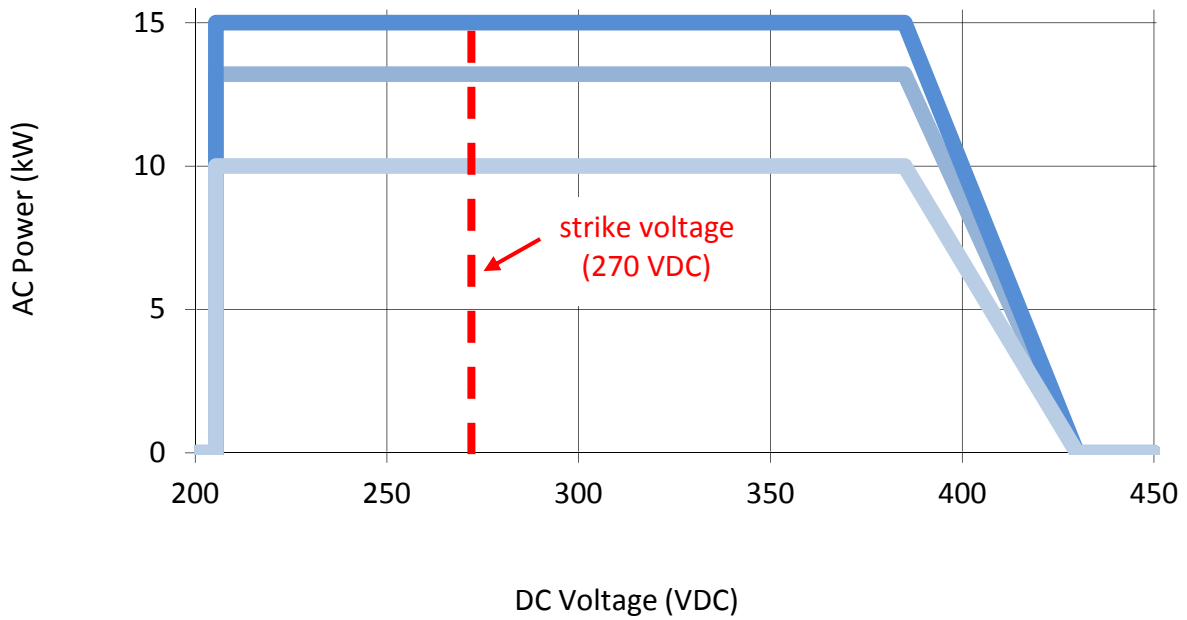

Figure 9.1 – AC Output Power of PVI 10-15KW Series Inverters

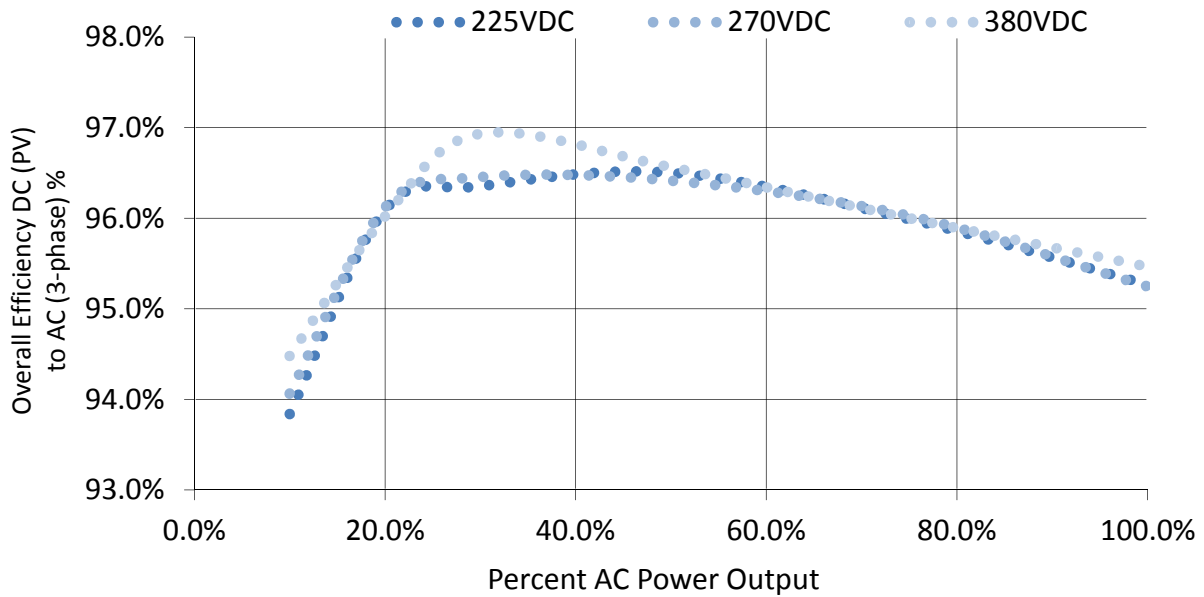

Figure 9.2 – PVI 15KW 480V Inverter Efficiency for 3 Different DC Voltage Inputs

## 9.4 Internal Circuit Diagram

The basic power flow within the PVI 10-15KW series of inverters is shown in the simplified one-line diagrams below. Note that the GFDI circuit is not depicted.

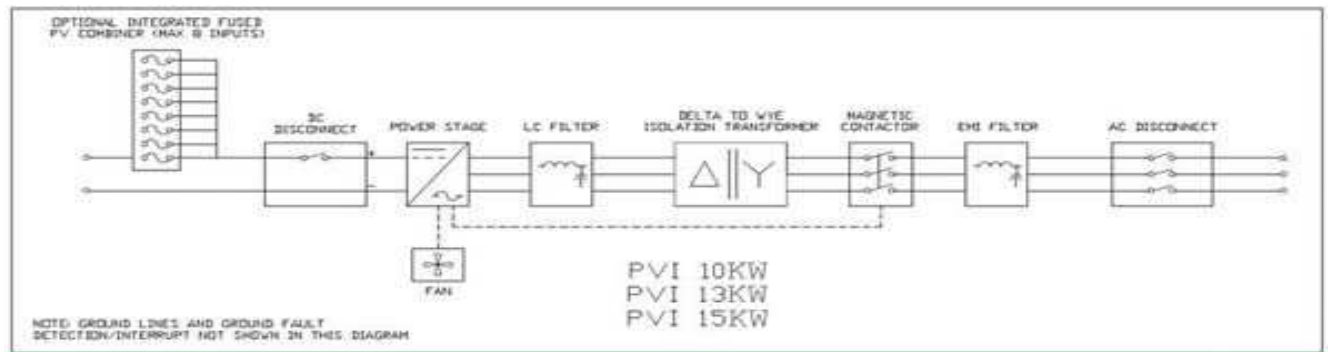

Figure 9.3 – Simplified Internal Circuit Diagram for PVI 10-15KW Series Inverters

## 10.0 Appendices

### 10.1 Appendix A – PVI 10-15KW datasheet

[http://www.solectria.com/?page\\_id=32](http://www.solectria.com/?page_id=32)

### 10.2 Appendix B – String Sizing Tool

[http://www.solectria.com/?page\\_id=30](http://www.solectria.com/?page_id=30)

### 10.3 Appendix C – Contact Information

Solectria Renewables, LLC  
360 Merrimack Street  
Building 9, 2<sup>nd</sup> floor  
Lawrence, Massachusetts 01843  
USA

Tel: 978.683.9700

Fax: 978.683.9702

Sales/ general info: [inverters@solectria.com](mailto:inverters@solectria.com)

Customer Support: [service@solectria.com](mailto:service@solectria.com)

Website: [www.solectria.com](http://www.solectria.com)

### 10.4 Authorized Distributors

See website for complete and updated listing: [www.solectria.com/?page\\_id=95](http://www.solectria.com/?page_id=95)

**10.5 Appendix D – UL1741 / IEEE 1547 / CSA22.2#107.1 Listing Letter**



**AUTHORIZATION TO MARK**

This authorizes the application of the Certification Mark(s) shown below to the models described in the Product(s) Covered section when made in accordance with the conditions set forth in the Certification Agreement and Listing Report. This authorization also applies to multiple listee model(s) identified on the correlation page of the Listing Report.

This document is the property of Intertek Testing Services and is not transferable. The certification mark(s) may be applied only at the location of the Party Authorized To Apply Mark.

<b>Applicant:</b>	Solectria Renewables, LLC	<b>Manufacturer:</b>	Solectria Renewables, LLC
<b>Address:</b>	360 Merrimack Street Lawrence, MA 01843	<b>Address:</b>	360 Merrimack Street Lawrence, MA 01843
<b>Country:</b>	USA	<b>Country:</b>	USA
<b>Contact:</b>	Mr. James Worden	<b>Contact:</b>	Mr. James Worden
<b>Phone:</b>	(978) 683-9700	<b>Phone:</b>	(978) 683-9700
<b>FAX:</b>	(978) 683-9702	<b>FAX:</b>	(978) 683-9702
<b>Email:</b>	www.james@solren.com	<b>Email:</b>	www.james@solren.com

**Party Authorized To Apply Mark:** Same as Manufacturer  
**Report Issuing Office:** Cortland, NY 13045 USA

**Control Number:** 3058249

**Authorized by:** *Chelsea Alexander*  
 William T. Starr, Certification Manager



This document supersedes all previous Authorizations to Mark for the noted Report Number.

This Authorization to Mark is for the exclusive use of Intertek's Client and is provided pursuant to the Certification agreement between Intertek and its Client. Intertek's responsibility and liability are limited to the terms and conditions of the agreement. Intertek assumes no liability to any party, other than to the Client in accordance with the agreement, for any loss, expense or damage occasioned by the use of this Authorization to Mark. Only the Client is authorized to permit copying or distribution of this Authorization to Mark and then only in its entirety. Use of Intertek's Certification mark is restricted to the conditions laid out in the agreement and in this Authorization to Mark. Any further use of the Intertek name for the sale or advertisement of the tested material, product or service must first be approved in writing by Intertek. Initial Factory Assessments and Follow up Services are for the purpose of assuring appropriate usage of the Certification mark in accordance with the agreement, they are not for the purposes of production quality control and do not relieve the Client of their obligations in this respect.

Intertek Testing Services NA Inc.  
 165 Main Street, Cortland, NY 13045  
 Telephone 800-345-3851 or 607-753-6711 Fax 607-756-6699

<b>Standard(s):</b>	UL 1741 Standard for Safety Inverters, Converters, Controllers and Interconnection System Equipment foer use with Distributed Energy Resources- 2nd Edition, Issued 2010/01/28.
	CSA C22.2 # 107.1-01, Issued 2001/09/01 Ed:3 General Use Power Supplies - (R2006)
	IEEE 1547-Issued:2003/06/12- Standard for Interconnecting Distributed Resources with Electric Power Systems
	IEEE 1547.1- Issue: 2005/06/09 IEEE Standard Conformance Test Procedures for Equipment Interconnecting Distributed Resources with Electric Power Systems
<b>Product:</b>	Utility – Interactive Photo Voltaic (PV) inverters
<b>Models:</b>	PVI 10 KW, PVI 13 KW and PVI 15 KW